

MARSURF | MARSURF XR 20 MARWIN



PC-BASED STATIONARY SURFACE MEASURING STATIONS

|
- 0 +

Mahr

EXACTLY

FROM THE THUMBNAIL TEST...

TO MARSURF



The latest information on MARSURF products can be found on our website: www.mahr.de, WebCode 158

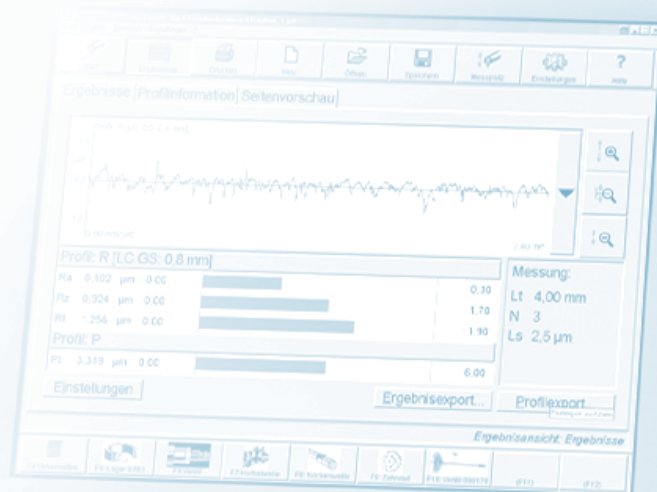

► I Wherever surface structures influence the function, processing or appearance of components or products, careful testing is essential. But how can surfaces be tested? At the start of the 20th century, experts still had to test by eye and touch. A practiced eye can detect features in the μm range, and even the much maligned thumbnail test delivered perfectly acceptable results. Now however, we live in an age of exchangeable parts, fits and internationalization, where subjective tests like this are no longer adequate. Today, computer-aided measuring instruments provide objective data. Measurement and evaluation have become considerably easier. For decades, Mahr has been a worldwide pioneer in this area, as demonstrated by the company's numerous innovations and patented solutions in the field of roughness metrology. The interplay between the stylus, drive and measuring setup plays a key role in influencing the quality of surface measurement tasks. This is where Mahr's core expertise comes in. We have succeeded in perfecting the stylus method which is now widespread throughout the world. Thanks to the range of optical sensors offered by MarSurf, we can also meet the latest requirements for non-contact measurement, for example where extremely soft materials or ultra-short measuring times are involved. Developed with Mahr quality, expertise and know-how, MarSurf is the solution for all your surface metrology needs.

▶ | MarSurf XR 20

PC-based Stationary Surface Measuring Stations	4
MarSurf XR 20	5
MarSurf XR 20 with GD 25 and ST-G	6
MarSurf XR 20 with GD 25 and ST 500	7
MarSurf XR 20 with PGK 120 and ST 500	8
MarSurf XR 20. Options	9
MarSurf XR 20 CNC / Workstation Version	10
MarSurf XR 20 with PMB-S Plug Gage	11
MarSurf XR 20 with PGK 120 and LS 1 / LS 10	11
MarSurf XR 20 with XT 20 Topography	12
MarSurf XR 20 with MarWin Software	14
MarSurf XR 20. Technical Data	16
PC-based Measuring Stations. MarSurf XCR 20	17
PC-based Measuring Stations. MarSurf LD 120	18
PC-based Measuring Stations. MarSurf XC 20/XP 20	19
PZK Drive Unit	20
GD 25 Drive Unit	21
PGK 120 Drive Unit	22
MFW 250 Surface Probe	24
RHTF, RT-250, RHTR and MFW 1250 Surface Probe	26
Focodyn, LS 1 / LS 10 Optical Surface Probes	27
Measuring Stands	28
Accessories	30

MarSurf. PC-based Stationary Surface Measuring Stations VERSATILE, HIGH-PERFORMANCE UNITS FOR INSPECTION ROOM AND LABORATORY

▶ | In surface metrology, a distinction is made between mobile units, stationary shop-floor units and PC-based surface measuring instruments. The latter provide the very best measurement and evaluation performance for surface measurement tasks. They fulfill all the requirements of a state-of-the-art PC-based measuring and evaluation system, including international standards, versatile evaluation methods, comprehensive documentation, large storage capacity, data export and import and networking with other systems. Comprehensive QA procedures ensure the highest quality and stability of software and hardware. | ◀

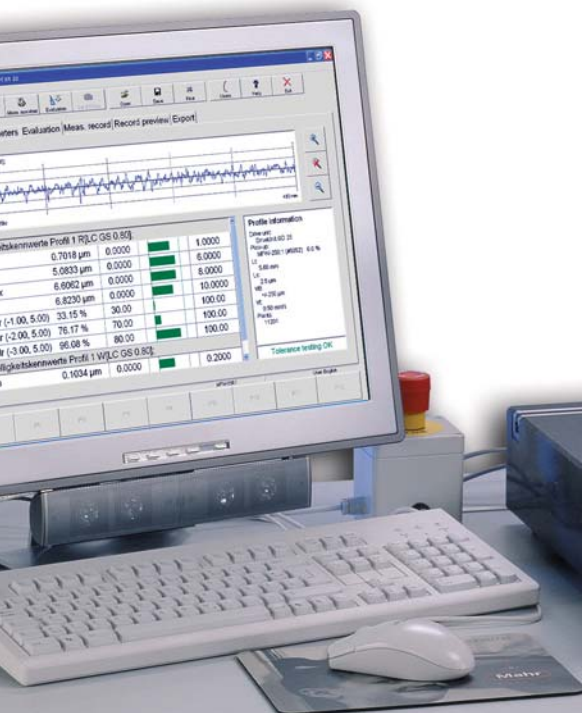
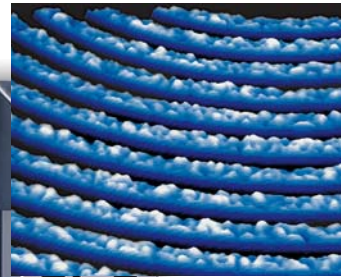
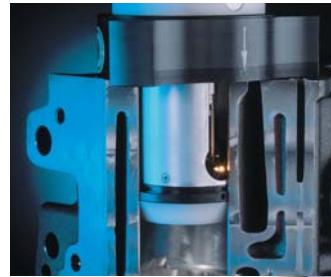
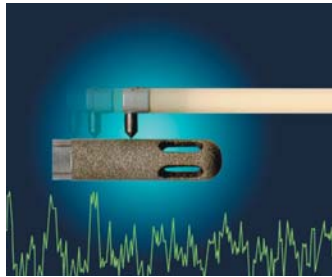
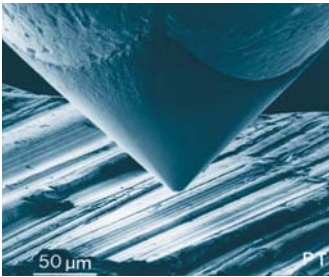

MarSurf XR 20

Roughness and waviness measurement made easy



Description

MarSurf XR 20 provides you with everything you need to start benefiting from Mahr's top-flight surface metrology. This PC-based unit covers all the common parameters and profiles in international standards, both in the inspection room and on the shop floor.

Clear, well-structured symbols and straightforward operating aids make this high-performance product easier to use. The **MarSurf XR 20** is the fruit of decades of surface metrology experience combined with up-to-the-minute, forward-looking technology.

MarSurf XR 20 is Mahr's future-focused roughness evaluation software.

Features

The roughness evaluation software features:

- A selection of over 80 parameters for R, P and W profiles in accordance with current ISO/JIS or MOTIF (ISO 12085) standards
- Ls band-pass filter in accordance with current standard; Ls can also be switched off or varied freely
- Tolerance monitoring and statistics for all individual parameters
- Comprehensive logging
- Quick measuring program creation in Teach-in mode

- Automatic function for selecting standard-compliant cutoffs and traversing lengths (patented)
- Support for different calibration methods (static and dynamic) with specification of Ra or Rz parameter
- Setting of maintenance and calibration intervals
- Wide range of measuring station configurations for customized applications
- Flexible system thanks to various options
- Different user levels, protecting the unit from operator error and ensuring that no unauthorized users are able to operate the device
- Multiple measurement, allowing various measurements on one or more parts to be documented on a single printout

MarSurf XR 20 with GD 25 and ST-G

Roughness and waviness measurement on small and medium-sized workpieces



Description

The compact design of this measuring station allows you to measure small and medium-sized workpieces simply and accurately. The properties of the **MarSurf XR 20** evaluation software and the associated evaluation options are described on pages 5 and 16.

Measuring Station Components

XR 20 measuring station with GD 25 and ST-G, consisting of:

MarSurf XR 20 including PC and standard control unit	Order No. 6268350
Windows XP operating system	Order No. 6268201*
Monitor TFT 17"	Order No. 5460041
Printer	Order No. 5460030
USB cable	Order No. 3018232
Adapter for control unit with ST-G	Order No. 7037687
GD 25 drive unit	Order No. 6721006
MFW skidless probe set	Order No. 6111404
ST-G measuring stand	Order No. 6710807
GD 25 mount for ST-D/F/G	Order No. 6851325
CT 120 XY table	Order No. 6710529

Optional:

PPS parallel vice **Order No. 6710604**

* Order No. language-dependent

GD 25 Drive Unit (see page 21)

- The GD 25 drive unit with built-in datum plane for precise measurements up to 25.4 mm (1 in)
- Rz residual values < 30 nm (1.18 µm) at a traversing speed of 0.1 mm/s (0.004 in/s)
- Can be used horizontally, vertically and upside down

MFW Skidless Probe Set (see page 24-25)

- Measuring range $\pm 250 \mu\text{m}$ (± 0.01 in) (with double probe arm length $\pm 500 \mu\text{m}/\pm 0.02$ in)
- Small tracing force of approx. 0.7 mN
- High probe linearity, deviation < 1%
- Supplied with 3 exchangeable standard probe arms (stylus tip geometry $2 \mu\text{m}$ (80 µin)/90°)
- Probe arm protection and probe arm protection with skid
- Cost-saving, modular probe system for exchangeable probe arms

ST-G Measuring Stand (see page 28)

- Granite plate measuring 500 mm x 300 mm (19.69 in x 11.81 in) (L x W) with central 10 mm (0.4 in) T-groove
- Measuring column with manual vertical adjustment over range of 300 mm (11.81 in) for the drive unit

Option (see page 20)

- | | |
|-------------------------------|--------------------------|
| • PZK set (drive unit) | Order No. 6990301 |
| • PZK mount | Order No. 6851328 |

MarSurf XR 20 with GD 25 and ST 500

The PC-based basic surface measuring station



Description

The illustration above shows the universal, PC-based basic measuring station for surface measurement.

The **GD 25** drive unit and ST 500 measuring stand provide you with simple and flexible solutions to your measurement tasks.

Measuring Station Components

MarSurf XR 20 including PC and standard control unit

Order No. 6268350

WIN XP operating system

Order No. 6268201*

Monitor TFT 17"

Order No. 5460041

Printer

Order No. 5460030

USB cable

Order No. 3018232

MCP 23 Standard

Order No. 7035195

GD 25 drive unit

Order No. 6721006

MFV skidless probe-set

Order No. 6111404

ST 500 measuring stand

Order No. 6710250

GD 25 mount for ST 500

Order No. 6851363

CT 200 XY table

Order No. 6710530

Optional:

PPS parallel vice

Order No. 6710604

GD-25 tube mount for ST 500

Order No. 6851364

* Order No. language-dependent

GD 25 Drive Unit (see page 21)

- GD 25 drive unit with built-in datum plane for precise measurements up to 25.4 mm (1 in)
- Rz residual values < 30 nm at a traversing speed of 0.1 mm/s (0.004 in/s)
- Can be used horizontally, vertically and upside down

MFV Skidless Probe Set (see page 24-25)

- Measuring range $\pm 250 \mu\text{m}$ (± 0.01 in) (with double probe arm length $\pm 500 \mu\text{m}/\pm 0.02$ in)
- Small tracing force of approx. 0.7 mN
- High probe linearity, deviation < 1%
- Supplied with 3 exchangeable standard probe arms (stylus tip geometry $2 \mu\text{m}$ ($80 \mu\text{in}$)/ 90°)
- Probe arm protection and probe arm protection with skid
- Cost-saving, modular probe system for exchangeable probe arms

ST 500 Measuring Stand (see page 29)

- Granite plate measuring 700 mm x 550 mm (27.56 in x 21.65 in) (L x W) with central 10 mm (0.4 in) T-groove
- Measuring column with motorized vertical adjustment over range of 500 mm (19.69 in) for the drive unit

MarSurf XR 20 with PGK 120 and ST 500 Measuring Stand

Roughness and waviness measurement on large, complex workpieces



Description

The **MarSurf XR 20** measuring station with **PGK 120** allows accurate measurement on large, complex workpieces.

Measuring lengths of up to 120 mm (4.72 in) and a comprehensive and very varied range of accessories provide solutions to your measurements tasks.

Measuring Station Components

MarSurf XR 20 including PC and standard control unit

Order No. 6268350	
WINDOWS XP operating system	Order No. 6268201*
Monitor TFT 17"	Order No. 5460041
Printer	Order No. 5460030
USB cabel	Order No. 3018232
MCP 23 Standard	Order No. 7035195
PGK 120 drive unit	Order No. 6721010
MFW skidless probe set	Order No. 6111404
ST 500 measuring stand	Order No. 6710250
PGK 120 mount for ST 500	Order No. 6851361
CT 200 XY table	Order No. 6710530

* Order No. language-dependent

PGK 120 Drive Unit (see pages 22 -23)

- PGK 120 drive unit with built-in datum plane for precise measurements up to 120 mm (4.72 in)
- Rz residual values < 30 nm (1.18 μin) at a traversing speed of 0.1 mm/s (0.004 in/s)
- Minimal guide deviation of X-axis < 0.3 $\mu\text{m}/120\text{ mm}$ (12 $\mu\text{in}/4.72\text{ in}$)

MFW Skidless Probe Set (see pages 24-25)

- Measuring range $\pm 250\ \mu\text{m}$ ($\pm 0.01\text{ in}$) (with double probe arm length $\pm 500\ \mu\text{m}/\pm 0.02\text{ in}$)
- Small tracing force of approx. 0.7 mN
- High probe linearity, deviation < 1%
- Supplied with 3 exchangeable standard probe arms (stylus tip geometry 2 μm (80 μin)/90°)
- Probe arm protection and probe arm protection with skid
- Cost-saving, modular probe system for exchangeable probe arms

ST 500 Measuring Stand (see page 29)

- Granite plate measuring 700 mm x 550 mm (27.56 in x 21.65 in) (L x W) with three 10 mm (0.4 in) T-grooves
- Measuring column with motorized vertical adjustment over range of 500 mm (19.69 in) for the drive unit
- Easily exchangeable mounts
- The measuring stand incorporates a manual mechanical angle adjuster for the drive unit

Options

Software option for **MarSurf XR 20**

Data transfer for exporting profiles to QS-STAT

Order No. 6292261	
PGN 3 geometric standard	Order No. 6820601
Mahr calibration certificate for PGN	Order No. 9027715
DKD calibration certificate for PGN	Order No. 6980102

“Dominant Waviness” Option

Evaluation in accordance with VDA 2007

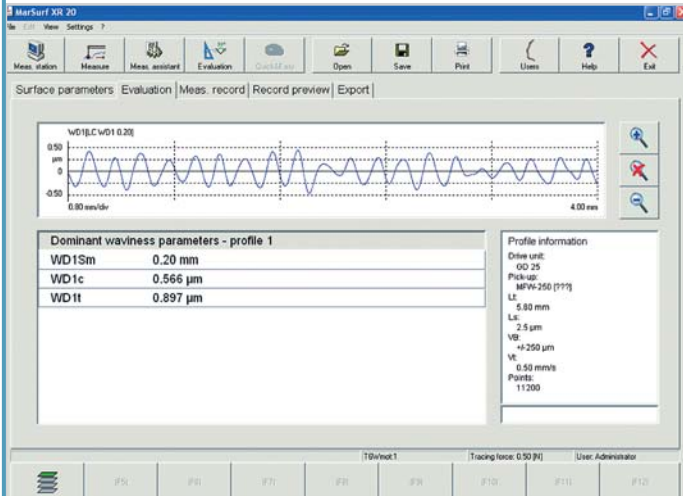

Description

The evaluation focuses on form deviations (waviness) occurring periodically on surfaces. The evaluation method described automatically identifies periodic dominant features on the surface, extracts these in the form of a new kind of waviness profile (WD profile) and derives parameters from them.

Examples:

Dominant waviness is used to check the following:

- Static tightness
- Dynamic tightness
- Noise prevention
- Prevention of high levels of wear and tear/malfunctions
- Preprocessing status

Order No. 6292203

“Data Transfer Tool” (DTT) Option

Enables data export, e.g. to qs-STAT

Mahr MarSoft Format

Exportieren als: ASCII | Eigenschaften | Schema: Default | Vorlage... | automatisch nach Schema exportieren

Alle Messergebnisse	Zusatzdaten	Belegnummer	Erlesen					
A	B	C	D	E	F	G	H	I
8	0.0000	0.0000	0.0000	0.0000				
9	0.0000	0.0000	0.0000	0.0000				
10	LT 5.60 mm	N 5	VB 50.0 µm					
11	Date	Time	Rdc [100.00 5.00] µm	R Mr (-1.00 5.00) %	R Mr (-2.00 5.00) %	R Mr (-3.00		
12	21.04.2004	00:00	-6.1129	18.3553	36.9910	64.1088		
13	06.05.2004	00:00	3.7643	4.8001	25.8301	32.2608	-26.4450	
14								

Auswahl der zu exportierenden Messergebnisse: Verknüpfen | Anpassen | Gesamte Tabelle übernehmen | Werte | Bezeichnen

A	B	C	D	E	F	G
1						
2	0.0000	0.0000				
3	0.0000	0.0000				
4	VB 50.0 µm					
5	Rdc [100.00 5.00] µm	R Mr (-1.00 5.00) %	R Mr (-2.00 5.00) %	R Mr (-3.00		
6	-6.1129	18.3553	36.9910	64.1088		
7	3.7643	4.8001	25.8301	32.2608	-26.4450	
8						
9						

Neu | Entfernen | Hinzufügen | Eigenschaften

Hilfe | Abfragen, ob exportiert werden soll. | OK | Abbrechen

Description

To export parameters, e.g. to **qs-STAT**, **MarSurf XR 20** uses the universal "Format" program. This program uses "patterns" to define the export parameters. Each individual measurement task requires its own "pattern file" which has to be created individually. Standard parameter export is in text format, with the individual columns separated by tabs. This format can be imported directly by all standard spreadsheet programs.

The following attributes are exported:

- Profile name; filter information for the group of parameters based on the buttons in the parameter box
- Date and time (optional, see "Export" tab)
- Profile number (if no multiple measurement)
- Name of calculated parameter

Order No. 6292261

MarSurf XR 20 CNC

Automates measurement with several axes



Description

The **XR 20 CNC** measuring station can be connected to the **ST 750 CNC** measuring stand and other additional axes to be controlled, e.g. for workpiece positioning.

The measuring assistant can be used to set measuring conditions such as positioning movements before or after the measurement. Users can complete their measurement tasks quickly and simply thanks to the clear, comprehensive layout. The MCP 21 manual control panel allows quick and easy joystick-based axis control.

Scope of Delivery

Depends on the relevant configuration



Leaflets available.

MarSurf XR 20 Workstation Version

Archiving and documentation made easy

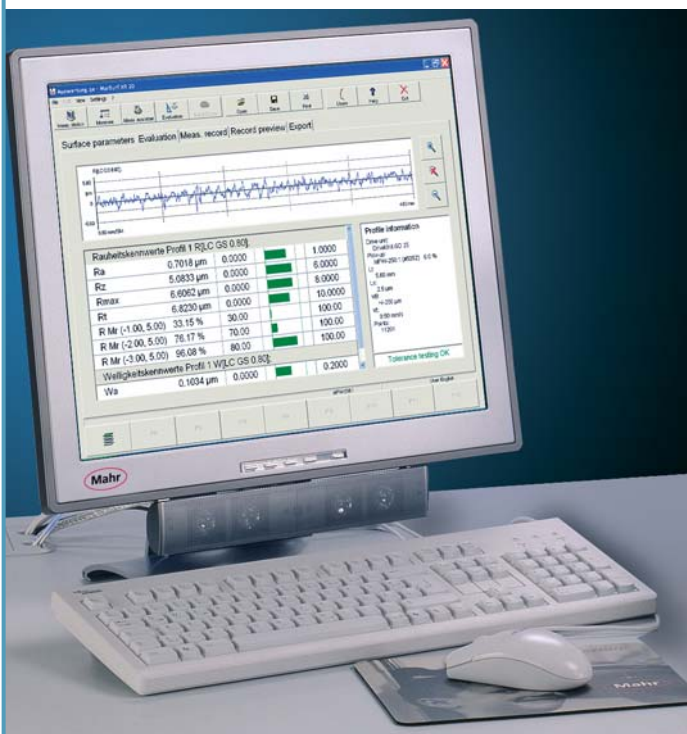

Description

Many measurement tasks need to be carried out "in situ" in the manufacturing environment. For example, measurements may be performed on workpieces that do not fit in the inspection room, but the measured values are to be evaluated and documented elsewhere. The workstation version of **MarSurf XR 20** is ideal for such cases.

MarSurf XR 20 with PMB-S Plug Gage

The ideal solution for quick and easy measurement in cylindrical bores



Description

MarSurf XR 20 with **PMB-S** is the ideal solution for quick and easy measurement in cylindrical bores of 75 mm to 100 mm (2.95 in to 3.94 in) (there is also an option which allows larger bores to be measured).

The system fixes itself in the bore and allows measurements up to a depth of 200 mm (7.87 in).

Measuring Station Components

MarSurf XR 20	Order No. 6268350
PMB-S	Order No. 6780001
Windows XP operating system	Order No. 6268201*
Monitor TFT 17"	Order No. 5460041
Printer	Order No. 5460030
USB cable	Order No. 3018232
PMB-S incl. accessories	Order No. 6780001
Calibration and storage station	Order No. 6780030
Adapter for control unit with ST-G	Order No. 7037687

MarSurf XR 20 with PGK 120 and LS 1 / LS 10



Description

MarSurf XR 20 also supports optical measurement using laser sensors that measure based on the auto-focus principle. As with tactile systems, evaluation is based on the stylus method. The contact diameter is 2 μm (80 μin).

The **LS 1** works with a focusing distance of 1 mm (0.04 in) and the **LS 10** with a focusing distance of 10 mm (0.4 in). Please feel free to contact us for information on the conditions of use and boundary conditions for this optical measuring principle.

Measuring Station Components

MarSurf XR 20	Order No. 6268350
Windows XP operating system	Order No. 6268201*
Monitor TFT 17"	Order No. 5460041
Printer	Order No. 5460030
USB cable	Order No. 3018232
MCP 23 Standard	Order No. 7035795
PGK 120 drive unit	Order No. 6721010
ST 500 measuring stand	Order No. 6710250
PGK 120 mount for measuring stand	Order No. 6851361
Laser sensor mount	Order No. 6851908
CT 200 XY table	Order No. 6710530
LS 1 laser sensor	Order No. 6112007

Alternative to LS 1:
LS 10 laser sensor **Order No. 6112008**

* Order No. language-dependent

MarSurf XR 20 with XT 20 Topography

Upgrade to a powerful topography measuring station

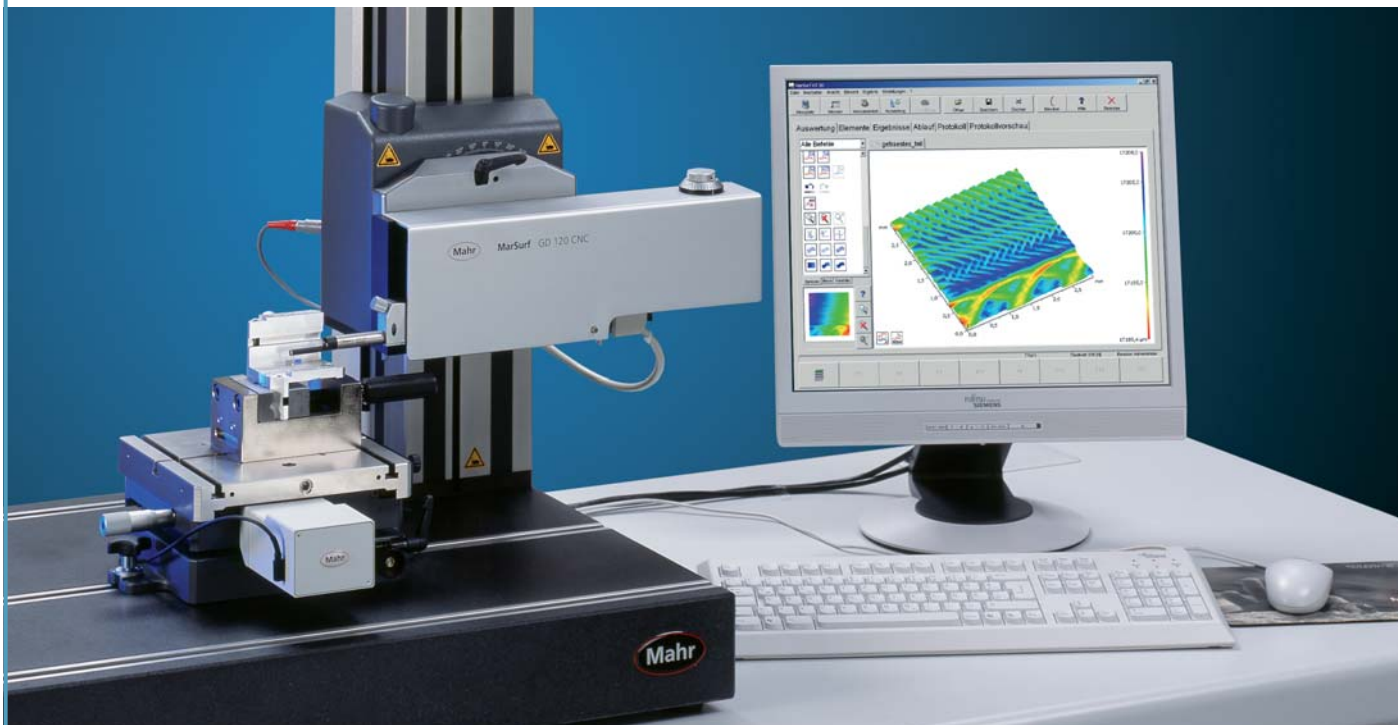

Description

For some applications, a single tactile profile of the surface form is inadequate. 3D topographical representation and evaluation offers the opportunity to obtain more comprehensive profile information. The **MarSurf XR 20** measuring station can be turned into a topography measuring station both simply and cost-effectively, whether based on an order or an upgrade requirement. All that is needed in addition to the standard scope of delivery is a **CT 200-MOT** Y-drive for the **CT 200** XY table and the **MarWin XT 20** software.

Technical Data CT 200-MOT

CT 200-MOT as described on page 30 but with motorized Y-adjustment.

Adjustment path in Y	175 mm (0.7 in)
Resolution	0.375 μ m (15 μ in)

Measuring Station Components

As described on pages 7 and 8, plus:
Topography measuring station extension

MarSurf XT 20 software
CT 200-MOT Y-drive

Order No. 6299034
Order No. 6710543

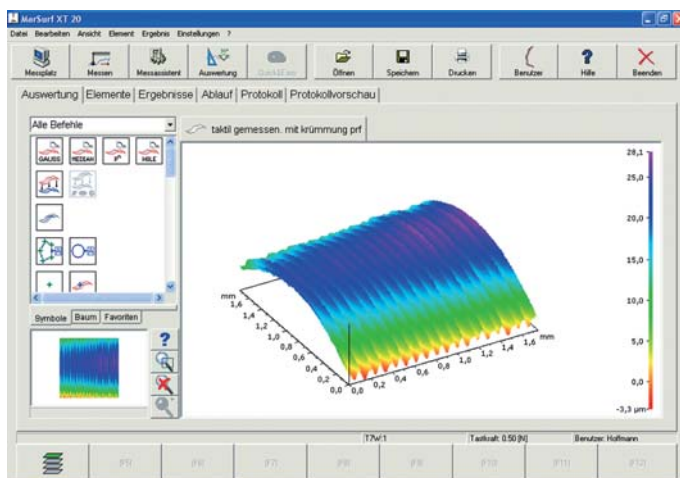

MarSurf XR 20 with XT 20 Topography – Application

Topographical analysis of machining grooves

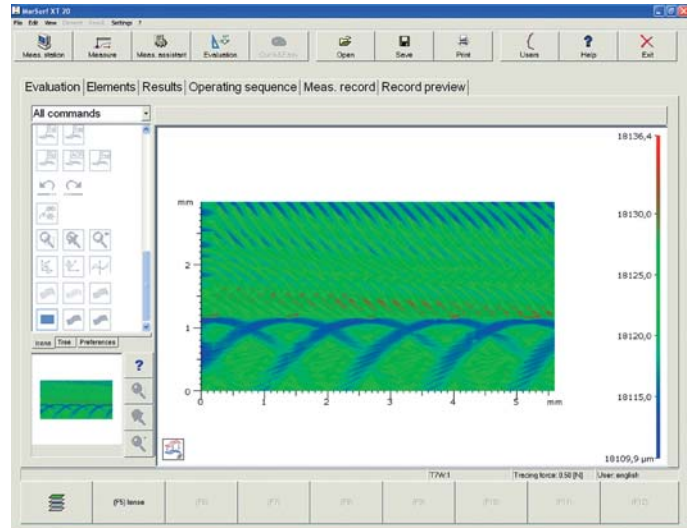

Different machining methods produce different surface structures. The machining structures are often very disparate which means that one single tactile profile cannot provide representative information about the profile character.

With a topography-based evaluation, more information is obtained about the properties of a surface.

MarSurf XR 20 with XT 20 Topography – Application

3D measurement of molds for use in the medical industry

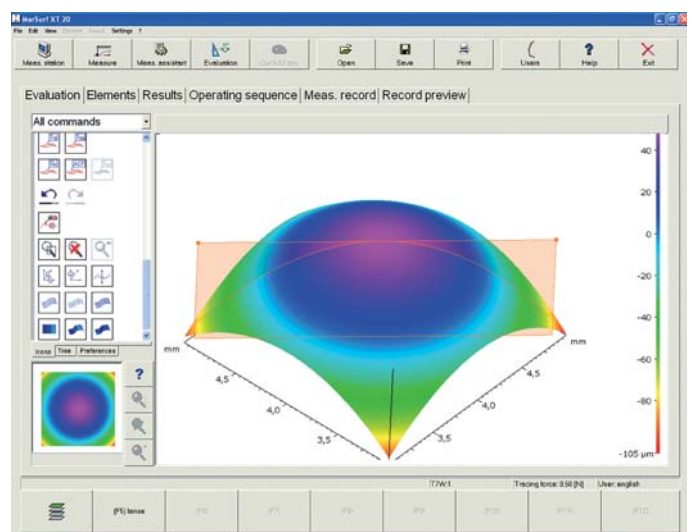
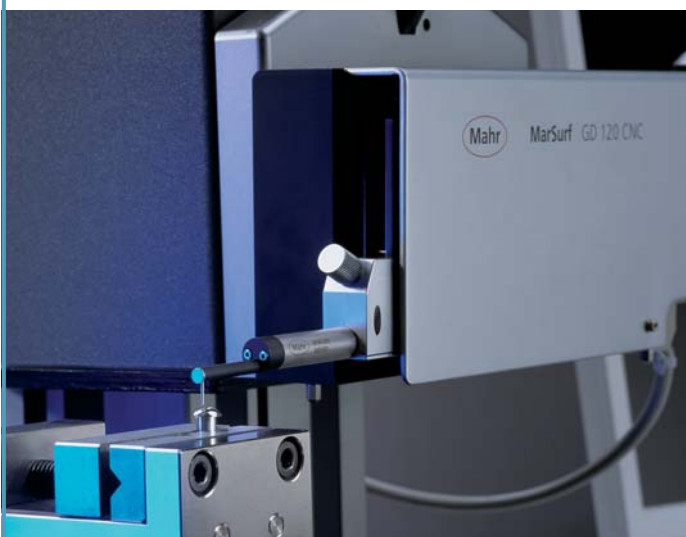

In the case of molds for items such as contact lenses, the surface topography is also of interest in addition to the individual profile for determining the roughness depth.

The form and surface roughness depth over the entire topography range are critical when it comes to product function.

MarSurf XR 20 with MarWin Software

MarWin-based software - user benefits

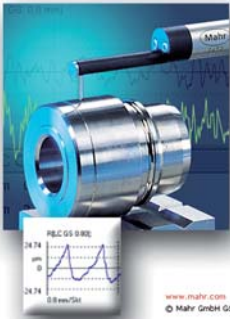

MarWin

MarSurf XR20

2.02-25 SP 3

www.mahr.com
© Mahr GmbH Göttingen

Mahr
EXACTLY

Description

The user-friendly **MarWin** software platform features many different measuring and evaluation criteria. Standardized symbols, operating sequences that are clearly structured even if applied differently, and clear-cut assignment of user rights are just a few of the many features making life easier for users.

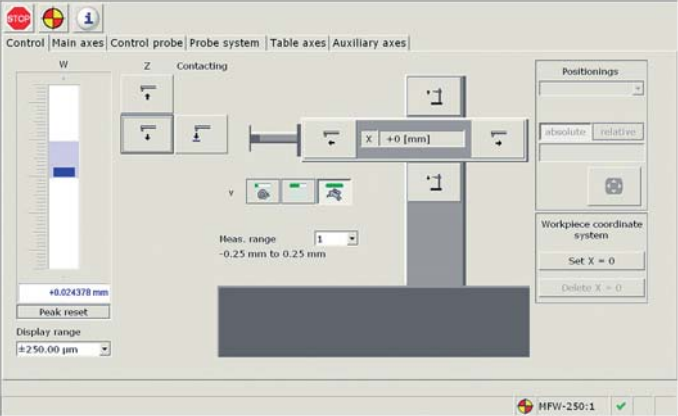

Control | Main axes | Control probe | Probe system | Table axes | Auxiliary axes

W Z Contacting

X: +0 [mm]

Meas. range: -0.25 mm to 0.25 mm

Display range: ±250.00 µm

MPW-250:1

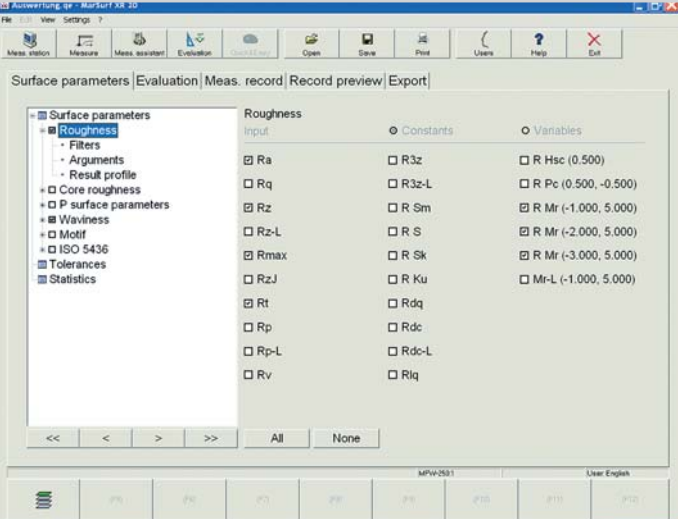

Surface parameters | Evaluation | Meas. record | Record preview | Export

Surface parameters

- [-] Roughness
 - [-] Filters
 - [-] Arguments
 - [-] Result profile
 - [+] Core roughness
 - [+] P surface parameters
 - [+] Waviness
 - [+] Motif
 - [+] ISO 5436
 - [+] Tolerances
 - [+] Statistics

Input	Constants	Variables
<input type="checkbox"/> Ra	<input type="checkbox"/> R3z	<input type="checkbox"/> R Hsc (0.500)
<input type="checkbox"/> Rq	<input type="checkbox"/> R3z-L	<input type="checkbox"/> R Pc (0.500, -0.500)
<input type="checkbox"/> Rz	<input type="checkbox"/> R Sm	<input type="checkbox"/> R Mr (-1.000, 5.000)
<input type="checkbox"/> Rz-L	<input type="checkbox"/> R S	<input type="checkbox"/> R Mr (-2.000, 5.000)
<input type="checkbox"/> Rmax	<input type="checkbox"/> R Sk	<input type="checkbox"/> R Mr (-3.000, 5.000)
<input type="checkbox"/> Rz-J	<input type="checkbox"/> R Ku	<input type="checkbox"/> Mr-L (-1.000, 5.000)
<input type="checkbox"/> Rt	<input type="checkbox"/> Rdq	
<input type="checkbox"/> Rp	<input type="checkbox"/> Rdc	
<input type="checkbox"/> Rp-L	<input type="checkbox"/> Rdc-L	
<input type="checkbox"/> Rv	<input type="checkbox"/> Rlq	

MPW-250:1 User English

It is possible to add further **MarWin**-based software items such as **XT 20** topography, **XC 2/XC 20** contour evaluation and many others at any time. Simple measuring station illustrations showing the measuring setup's axes make work quick and easy.

Results, profiles, globally standardized parameters and characteristic curves can be activated at a click and output in the record. The relevant inputs can be selected directly using the **Surface parameters, Evaluation, Record, Record preview** and **Export** file cards, resulting in quick and easy operation for users.

MarSurf XR 20 with MarWin Software



The measuring assistant allows targeted setting of all measuring conditions required for the measurement task. For example, text tips guiding users allow positioning movements to be entered both before and after measurements.

MarSurf XR 20. Configuration of a Standard Measuring Station

The advantages of **MarWin** technology extend beyond software-related solutions to the entire coordinated measuring station concept, e.g. control unit, control elements and many other items.

For a standard measuring station or a 7-axis CNC measuring station, all manner of solutions are possible with the fully coordinated **MarWin** technology.

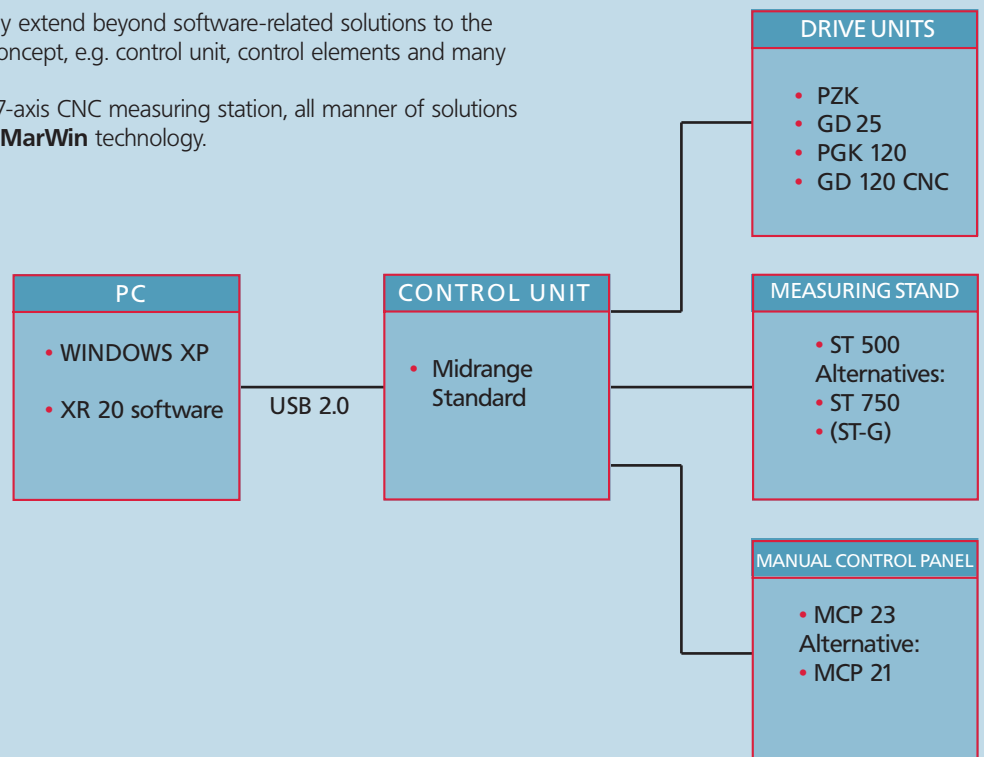

MarSurf XR 20. Technical Data

Measuring principle	Stylus method	Traversing speeds (Vt)	0.1 mm/s and 0.5 mm/s (0.004 in/s, 0.02 in/s)
Probes	R probes, MFW 250 Focodyn*, LS 1* and LS 10* optical probes (*only in conjunction with PGK 120 or GD 120 CNC drive unit)	Parameters	
Drive units	PZK, GD 25, PGK 20, PGK 120, GD 120 CNC	Roughness parameters:	Ra, Rq, Rz (Ry in acc. with JIS corr. to Rz), Rmax, R _{Pc} , Rz (JIS), Rt, R _p (R _{pm} in acc. with ASME corr. to R _p), Rv, R3z, RSm, RS (corr. to S in acc. with JIS), Rsk, Rku, Rdq, Rlq, Rdc, R HSC, RMr*, RMr*, RMr*
Measuring ranges MFW 250:	±25 µm, ±250 µm, (up to ±750 µm); ±1,000 µin, ±10,000 µin (up to ±30,000 µin)	Core roughness parameters:	Rk, Rpk, Rvk, Rpkx, Rvkx, Mr1, Mr2, A1, A2, Vo
Profile resolution / resolution		P profile parameters:	Pa, Pq, Pt, Pp, Pv, PSm, Psk, Pku, Pdq, Plq, Pdc, P HSC, Ppc, PMr*, PMr*, PMr*
Vertical	±25 µm / 0.7 nm (±1,000 µin / 0.02 µin) ±250 µm / 7 nm (±10,000 µin / 0.2 µin) ±2500 µm / 50 nm (±100,000 µin / 2 µin) Approx. 100,000 steps per measuring range	W profile parameters:	Wa, Wq, Wt, Wp, Wv, WSm, Wsk, Wku, Wdq, Wdc, WMr*, WMr*, WMr*
Horizontal	Points spaced in accordance with DIN EN ISO 3274 (11,200 points over 5.6 mm measuring length; user-defined max. 240,000 points possible)	Motif parameters (ISO 12085):	R, AR, W, AW, Rx, Wx, Wte, Nr, Ncrx, Nw, Cpm, CR, CF, CL
Profile types	D, P, W, R (profile inversion possible) Optional: Dominant waviness	ISO 5436 parameters:	Pt5436, D
Filter types	Profile filter in accordance with DIN EN ISO 11562 (digital, phase-correct) RC filter (digital) Special filter in accordance with DIN EN ISO 13565-1 K1 special filter	Parameter lists:	Rz-L, Rp-L, R3z-L, Rdc-L, RMr-L Pdc-L, PMr-L
Form elimination	ARC filter	"Dominant waviness" option:	WDSmMin, WDSmMax, WDSm, WDC, WDT
Cutoff wavelengths	0.08 mm; 0.25 mm; 0.8 mm; 2.5 mm; 8 mm/free input (.003 / .010 / .032 / .100 / .320 in)	Characteristic curves	Profile, Material ratio (Abbott-Firestone curve) Amplitude density curve (ADC)
Traversing lengths	Automatic; 0.56 mm; 1.75 mm; 5.6 mm; 17.5 mm, 56 mm, (.022 / .070 / .224 / .700 / 2.240 in), Measurement up to stop, variable	Calibration	Static and dynamic in acc. with Ra or Rz
Number of sampling lengths	1 to 50 (default: 5)	Calibration interval	Yes, monitored
Special traversing lengths	0.1 mm to feed length adjustable (0.008 in to 12 in)	Tolerance display	Yes (for all individual values)
Low-pass Ls	2.5 µm / 8 µm / 25 µm (100 µin / 320 µin / 1,000 µin) in accordance with DIN EN ISO 3274, freely variable and can be switched off	User administration	Yes (with assignable user rights)
		Automatic function	Automatic selection of cutoff conforming to DIN EN ISO 3274
		Statistics	X, S, max., min., not within tolerance, invalid measurements
		Languages	English, French, German, others on request
		Software can be run on	WINDOWS XP
		MarSurf XR 20 including PC and standard control unit	Order No. 6268350
		Subject to technical changes.	
		* Material ratio calculation with mean line or CREF reference	

PC-based Measuring Stations. MarSurf XCR 20

The new generation of combined roughness and contour measurement systems



Description

MarSurf XCR 20 is ideal for combining contour and roughness depth evaluation.

MarSurf XC 20 + MarSurf XR 20 = MarSurf XCR 20

This system includes absolutely everything you need, saving both time and space. There are separate operating levels for the roughness-depth and contour software. **MarSurf XCR 20** is Mahr's top surface measurement system and enables even semi-automated operating sequences such as measuring stand positioning (**ST 750 CNC**) to be performed with ease.

Features

- Space because both drive units (**MarSurf PCV 200** contour drive unit and **GD 25** roughness drive unit) can be adapted using the corresponding combi-mount on the **ST 500** or **ST 750** measuring stand
- High-precision contour and roughness evaluation with the **MarSurf LD 120** measuring system on components requiring a large stroke and very high resolution
- Option of rapidly switching between roughness and contour measurements thanks to straightforward changeover within the software platform and changing of mechanical components such as drive unit and probe

Versions

- Combi-measuring station with one measuring stand and two drive units (**PCV 200** and **MarSurf GD 25**)
- Combi-measuring station with quick-change mounts (**PGK 120**, **PCV 200**)
- **MarSurf LD 120** enables high-precision contour and roughness evaluation on components

Measuring Station Components

MarSurf XCR 20 measuring station (roughness and contour)	
MarSurf XCR 20 standard consisting of:	
PC and standard control unit	Order No. 6268380
Windows XP country package	
professional en	Order No. 62682xx
17" TFT monitor	Order No. 5460041
Printer	Order No. 5460030
USB cable	Order No. 3018232
MCP 23	Order No. 7035195
GD 25	Order No. 6721006
MFW-250	Order No. 6111404
PCV	Order No. 6720810
Standard calibration set	Order No. 6820124
MarSurf ST 500 measuring stand	
with 700 x 550 mm granite plate	Order No. 6710250
GD 25/PCV 200 combi-mount	Order No. 6851369
CT 200 XY table	Order No. 6710530

Note: It is possible to upgrade the **MarSurf XR 20** measuring station to a **MarSurf XCR 20**.

PC-based MarSurf Measuring Systems. MarSurf LD 120

MarSurf LD 120. Two in one. Contour and roughness depth in a single stroke

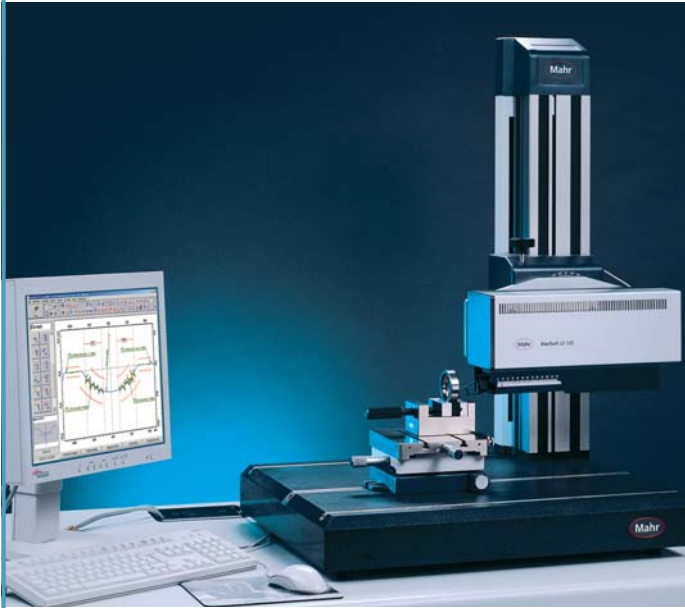

- Software can be used to set measuring forces from 0.5 to 30 mN which remain constant over the entire measuring stroke, ensuring flexibility and reliability. You can select the optimum measuring force to match the material characteristics of the workpiece and the probe arm of your choice
- Probe arms changed without re-calibration. Storage of calibration data for each probe arm and the magnetic probe mount ensure high reproducibility

For further information, please see the MarSurf LD 120 catalog.



Leaflets available.

Description

MarSurf LD 120 is the new high-quality, high-precision **contour** and **roughness measuring station** with integrated optical measuring system.

It performs roughness and contour evaluations in a single stroke. To complete both these measurement tasks with a single measurement, you need a high-precision measuring system that supports both the relatively large measuring stroke for the contour in radii, on slopes or in freeform areas and the resolution in the nm range for the roughness depth measurement.

Features

- The magnetic probe mount ensures flexibility by supporting a wide range of probes that can be easily exchanged, while maintaining a high level of reliability
- Positioning accuracy in the μm range when exchanging probes, and collision protection, rigidity and stability with resolutions in the nm range
- Reliable results thanks to a calibration procedure specially geared to high accuracy

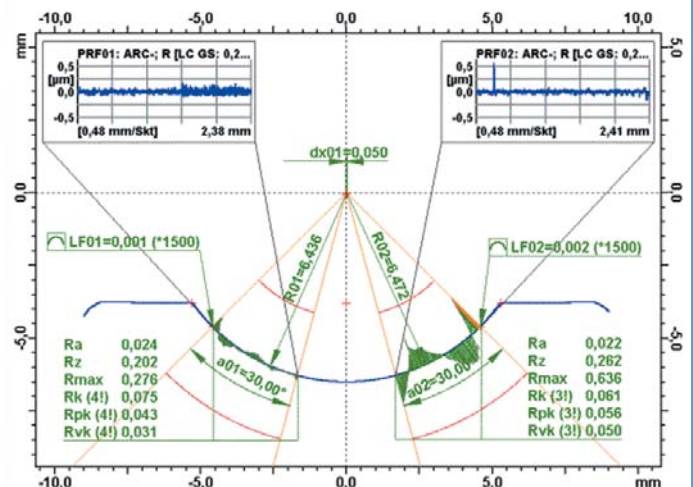
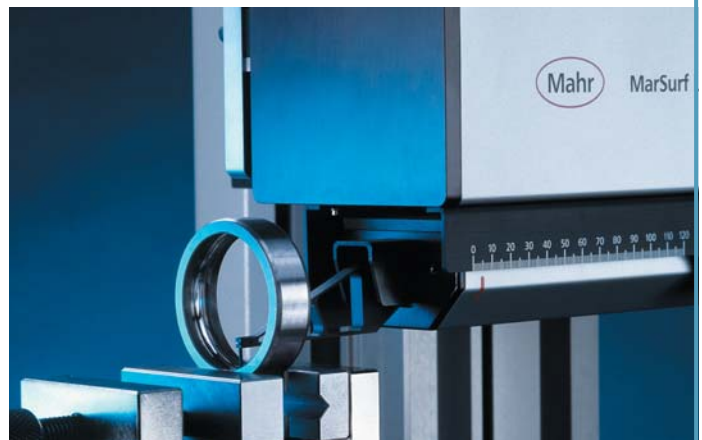

Other PC-based MarSurf Measuring Systems

MarSurf XC 20 / XC 2.
The new generation of contour measurement systems



Description

What started over 30 years ago with the Conturograph - consisting of a drive unit and x-y plotter - has today developed into a state-of-the-art contour measurement system with the very latest technology. This perfectly coordinated configuration of instruments meets the highest performance standards. Both the drive unit and the measuring stand are controlled and positioned using the reliable measurement and evaluation software. The fast, straightforward and cost-effective 2D contour measuring system is increasingly winning out over other systems.

Mahr offers you two alternatives for high-precision contour measurement:

- **MarSurf XC 2** for entry-level precise contour measurement and
- **MarSurf XC 20** - simply the best when it comes to contour evaluation

Features

- Automatic lifting and lowering of the probe arm with adjustable speed
- Variable setting of measuring force from 1 mN to 120 mN
- Measuring force remains constant over the entire measuring range
- Collision protection thanks to patented probe arm mount
- Probe arms changed without re-calibration

Further detailed information is available in separate documentation on the **MarSurf XC 20 / XC 2**.



Leaflets available.

MarSurf XP 20



Description

MarSurf XP 20 is one of the top-end MarWin-based measuring stations. Customized measurement tasks can be performed in a rational, largely automated fashion.

The Mahr software platform **MarWin** is a modular control and evaluation system with significant advantages.

This multi-product software platform provides users with a uniform basis, thereby ensuring the operational and functional reliability particularly required in automated processes.

Quick and easy configuration is achieved through the use of standardized mechanical and electronic measuring station components.

The overall design gives you reliability and flexibility for solving your measurement tasks, in particular for measuring stations used in manufacturing environments with CNC functions.

Quotations are geared towards customer requirements. Please contact your advisor for further details.



Leaflets available.

PZK Drive Unit



Features

PZK drive unit with integrated probe

This Perthometer system consists of the small, handy PZK drive unit and the integrated, inductive MFW probe. Probe arms can be changed in a matter of seconds. A built-in datum plane allows both skidded and skidless measurements.

The established benefits of the MFW probe are the large measuring range and high linearity and resolution. The measuring force, the geometrical data for the stylus tip and all the technical details are DIN/ISO-compliant.

The traversing length is set on the Perthometer. After the measurement, the probe automatically returns to the start position.

PZK hand-held mount with vertical and inclination adjustment

The PZK set includes a hand-held mount. This turns the PZK system into a universal measuring system:

The bottom of the hand-held mount takes the form of a V-block, enabling flat and cylindrical workpiece contours to be measured. The hand-held mount can be fitted directly to the measuring stand mount for operation on the measuring stand.

Two generously proportioned adjusting screws allow sensitive and precise vertical and inclination adjustment for skidless measurements. Perthometers can be connected to help users achieve rapid and precise positioning. The probe's inclination and height are shown on the display.

For skidded measurements, the probe arm protection is replaced with the version including skid.

PZK set

consisting of:

Order No. 6910301

Hand-held mount with vertical and inclination adjustment PZK drive unit with built-in inductive probe

Order No. 6850734

Probe arm protection

Order No. 6721101

Probe arm protection with skid

Order No. 6851815

Probe arm, 5.5 mm (0.2 in) cranked, 2 µm (80 µin), 90°

Order No. 6851814

Order No. 6851816

The built-in MFW probe and the quick-change probe arms ensure a wide variety of applications. The range also includes other probe arms for special measurement tasks.

Technical Data

PZK drive unit

Traversing length	Up to 20 mm (0.79 in)
Traversing direction	Longitudinal
Measuring range	± 250 µm (±0.01 in)
Dimensions	Dia. 24 mm (0.95 in), L approx. 120 mm (4.72 in)
Traversing speed	0.1 mm/s, 0.5 mm/s (0.004 in/s, 0.02 in/s)
Operating position	Any orientation
Guide deviation	0.35 µm/20 mm (14 µin/0.787 in)

PZK hand-held mount

Vertical range	4 mm (1.58 in)
Inclination range	± 20 µm/mm
Dimensions (L x W x H)	81.5 mm x 32 mm x 56.5 mm (3.21 in x 1.26 in x 2.22 in)
with standard front plates	93,5 mm x 34 mm x 60 mm (3.68 in x 1.34 in x 2.36 in)
Positioning accuracy	
for vertical adjustment	1 µm (40 µin)
for inclination adjustment	0.1 µm (4 µin)

Accessories

A wide range of accessories opens up virtually unlimited applications for the PZK drive unit, e.g. measuring on cylinders with diameters of 14 mm (0.55 in) and over with the

Pair of V-blocks **Order No. 6850537**

or measuring small cylindrical bodies with diameters of 2 mm (0.08 in) and over with the

Add-on V-block **Order No. 6850536**

PZK mount for measuring stand **Order No. 6851328**
ST-D, ST-F, ST-G

GD 25 Drive Unit



Description

With built-in datum plane. Quiet drive unit with low-vibration design. Compact, robust and rigid casing. The base of the unit takes the form of a V-block. Motorized vertical adjustment for lifting and lowering the probe and for automatic zero setting. All non-skidded probes and single/dual-skid probes of types "M" and "R" can be used.

Roughness, waviness and form deviations can be recorded in conjunction with the **MFW 250** and **RFHTB** non-skidded probes. The compact, universal casing design means that the instrument can be used as a hand-held, table-top or measuring stand unit. It can also be used horizontally, vertically or upside down.

The unit is designed to allow measurement in pipes and bores and, with diameters of 68 mm (2.68 in) and over, the entire drive unit can be inserted. With smaller diameters, it is only possible to insert part of the probe protection with its continuous V-block.

The datum plane is aligned relative to the workpiece using the inclination adjusting screw. The motorized vertical adjuster readjusts the overall probe position so that the stylus tip automatically remains in the center of the measuring range.

Thanks to its V-block, the **GD 25** drive unit is suitable for both flat and cylindrical workpieces. Centering takes place on the continuous V-block up to workpiece diameters of 72 mm (2.83 in).

For larger diameters and flat surfaces, the integrated support feet are used.

The V-block can accommodate cylindrical workpieces for upside-down measurements.

At the start of the measurement, the probe is lowered onto the workpiece using the motorized zero setting function. Once the measurement has been completed, the entire probe is returned to the probe protection and lifted. Return travel is protected in the upper position and ends in the front starting position.

Technical Data

GD 25 drive unit	Order No. 6721006
Traversing length	Up to 25.4 mm (1 in), adjustable on evaluation unit
Traversing speed	0.1 mm/s or 0.5 mm/s (0.004 in/s or 0.02 in/s), set automatically by evaluation unit
Rz residual value	< 30 nm (1.2 μin)
Guide deviation	0.2 μm/20 mm (787 in/0.787 in)
Vertical range	4 mm (0.16 in) (motorized)
Inclination range	± 10 μm/mm (± 1 mm/100 mm) manual
Probe mount	For MFW 250 and "R"-type probes
V-block	For positioning on cylindrical workpieces with diameters of 30 mm to 72 mm (1.81 in to 2.83 in), inside diameter from 68 mm (2.68 in)
Feet	For positioning on cylindrical workpieces with diameters of 72 mm (2.83 in) and over and flat workpieces
Dimensions (L x W x H)	148 mm x 36 mm x 60 mm (5.83 in x 1.42 in x 2.36 in)
Weight	Approx. 1.2 kg (2.65 lbs)

For high-precision measurement tasks we recommend the GD 25 plus (technical data available on request).

Accessories

PGK/GD 25 mount for measuring stand

ST-D, ST-F and ST-G measuring stands	Order No. 6851325
ST 500 measuring stand (standard)	Order No. 6851363
Special tube mount for ST 500 measuring stand see below	Order No. 6851364



PGK 120 Drive Unit

Perfect skidless measurement

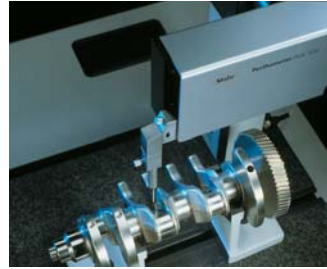

Description

All the benefits of the **PGK 120** drive unit can be used with **MarSurf XR 20 / XCR 20** Windows® evaluation software.

All established optical and tactile probes can be connected to the **PGK 120**, e.g. R probes, **MFW** non-skidded probes, **LS 1/10** and **Focodyn**.

Direct connection to Perthometer S2. The **PGK 120** can also be connected to the older S3P/S4P Perthometers without an adapter and used up to a traversing length of 56 mm (2.2 in).

Features

Mahr has been setting top surface metrology standards for 50 years. Our products are regarded as benchmarks and our drive units in particular are in a class of their own, as reiterated by the **PGK 120**.

- 120 mm (4.72 in) traversing length for all conceivable roughness and waviness measurement tasks
- Tiny X-axis guide deviation: <math>< 0.3 \mu\text{m}/120 \text{ mm}</math> (12 $\mu\text{in}/4.72 \text{ in}</math>)$
- Residual noise barely discernible
Rz residual value <math>< 30 \text{ nm}</math> (1.18 $\mu\text{in}</math>)$
- Patented motorized probe zero setting over 22 mm (0.87 in) - saves time and setup work
- Automated measuring processes: Lowering - zero setting - measuring - lifting of probe
- Integrated into the drive unit: Manual vertical adjustment of the probe over 50 mm (1.97 in)
- Transverse tracing with non-skidded probes required? No problem for the **PGK 120**
- Lateral vertical tracing? By all means!
- The ideal probe for every measurement task - optical and mechanical
- Probes exchanged without tools
- Can be swiveled on the measuring stand in a matter of moments

MarSurf PGK 120

Order No. 6721010

Probe mount, vertical

Order No. 6851905

- 90° downwards and rotated 90°
- For lateral measurement/tracing
- Workpiece easy to change from the front
- Skidless measurement, e.g. with MFW 250 probe
- Axial traversing direction

Probe mount, transverse

Order No. 6851904

- Can be used axially and at 90° (transversely)
- For example, for measurement on main and stroke bearings of rankshafts and other axial measurements on cylindrical workpieces
- For MFW and R probes
- Skidless measurement, e.g. with MFW 250 probe

Probe mount, axial

Order No. 6851901

V-block base

Order No. 6851907

MFW probe arm, 20 mm (0.78 in) cranked required

Carrying handle

Order No. 6851903

- Designed for use in the manufacturing environment
- Can be used for cylinder diameters of 90 mm to 370 mm (3.55 in to 14.58 in)
- Inclination adjustment on the drive unit
- Motorized lowering and zero setting of probe over 22 mm (0.87 in) after drive unit positioning
- Skidless measurement, e.g. with MFW 250 probe
- Probe parking position moved to automatically after each measurement
- Straightforward and reliable handling using tried-and-tested Mahrstandard components

It is possible to measure and evaluate the roughness and waviness of small workpieces with the compact measuring station without measuring stand. The small measuring circle means that there is hardly any vibration. Ideal for series measurements in the manufacturing environment.

**Compact measuring station
XY table**

**Order No. 6851906
Order No. 6851909**

PGK 120 Drive Unit. Technical Data

Traversing length (depends on evaluation instrument used)	Up to 120 mm (4.72 in)
Traversing speed	0.1 mm/s and 0.5 mm/s (0.004 in/s, 0.02 in/s)
Constant speed of X-drive in horizontal operation at 0.5 mm/s (0.02 in/s)	< ± 1 %
Return travel speed	~ 2 mm/s (0.08 in/s)
Positioning speed in measuring direction	0.5 mm/s (0.02 in/s)
Contacting speed in Z-direction	~ 1.0 mm/s (0.04 in/s)
Positioning speed during return travel	~ 2 mm/s (0.08 in/s)
Guide deviation with MarSurf XR 20	0.3 µm/120 mm (12 µin/4.72 in); 0.15 µm/20 mm (6 µin/0.78 in)
Guide deviation with Perthometer S2	0.4 µm/120 mm (16 µin/4.72 in); 0.2 µm/20 mm (8 µin/0.78 in)
Manual vertical adjustment of probe, coarse	50 mm /1.97 in)
Motorized vertical adjustment of probe, fine	≤ 22 mm (0.87 in)
Manual inclination adjustment of datum plane	± 1°
Perpendicularity deviation of Z-axis relative to X-axis	0,5°
Safety contacts for motorized movement to switch off the relevant feed motor	Front, back, top, bottom
Reproducibility of start point	< 0.05 mm (0.002 in); < 0.002 mm (0.0008 in) at const. temp. ±2 °C (±3.60 °Ra)
Inclination range on measuring stand	+30° ... 0° ... 45°

Standard tracing (skidless measurement with probe mount, axial, without measuring stand, e.g. on compact measuring station)

R _z residual value at 0.1 mm/s (0.004 in/s)	≤ 30 nm (1.18 µin)
R _z residual value at 0.5 mm/s (0.02 in/s)	≤ 50 nm (1.97 µin)

Transverse tracing (skidless measurement with probe mount, transverse, without measuring stand)

R _z residual value at 0.1 mm/s (0.004 in/s)	≤ 60 nm (2.36 µin)
R _z residual value at 0.5 mm/s (0.02 in/s)	≤ 150 nm (5.91 µin)

Vertical tracing (skidless measurement with probe mount, vertical, on measuring stand)

R _z residual value at 0.1 mm/s (0.004 in/s)	≤ 50 nm (1.97 µin)
R _z residual value at 0.5 mm/s (0.02 in/s)	≤ 130 nm (5.12 µin)

Operating temperature	20 °C ± 2 °C (68 °F ± 3.60 °Ra)
Storage temperature	5 °C to 35 °C (41 °F to 95 °F)
Relative humidity	Max. 85 %
Casing dimensions (L x W x H)	330 mm x 60 mm x 120 mm (13.00 in x 2.36 in x 4.73 in)
Weight	5 kg (11.01 lbs)

Subject to technical changes. This data relates to use of an MFW probe with standard probe arm length and measurements in a low-vibration environment.

Order No. 6721010

MFW 250 Surface Probe

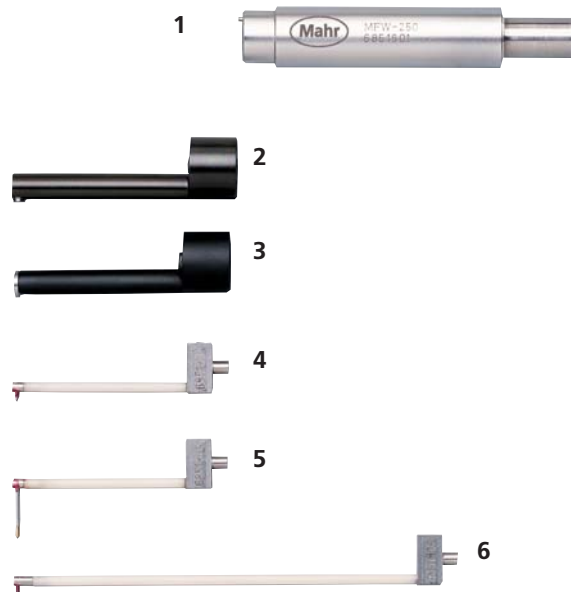
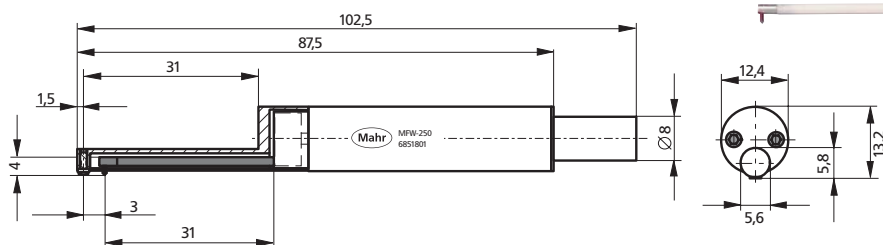
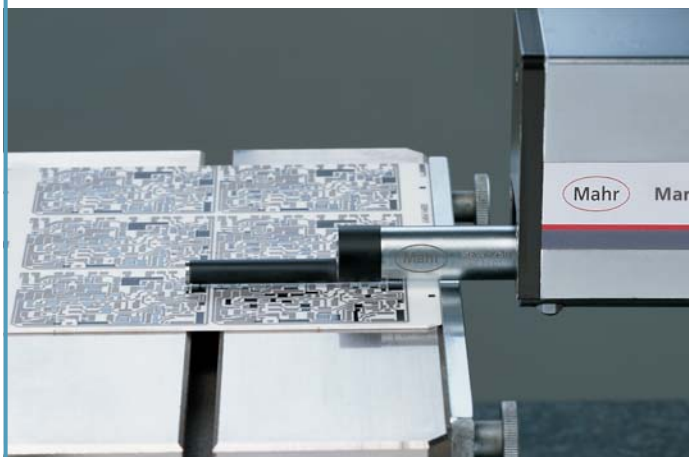

Description

The **MFW probe** which can be changed over for roughness and waviness measurements features high linearity (deviation < 1%), high resolution (100,000/200,000-fold) and a large measuring range ($\pm 250 \mu\text{m}$ / ± 0.01 in). When using double-length probe arms, the measuring range increases to $\pm 500 \mu\text{m}$ (± 0.02 in). The fact that it is easy to change the probe arms enables versatile use. The robust, rigid design means that there is no natural vibration or resonance.

When combined with the **GD 25** and **PGK 120** drive units, the **MFW probe** can be used as a skidless or skidded probe. With the **PGK 120** drive unit, the traversing directions can be varied in different ways (see MarSurf PGK 120 description).

Using the **MFW 250** on the **GD 25** drive unit and the **Perthometer S2** or **MarSurf XR 20 / XCR 20** enables the best possible application of benefits such as motorized zero setting with automatic lifting of the probe.

The special probe arms described below are to be used as required by the relevant application. We recommend our applications engineering department for advice and any test measurements required.

Other probe arms and stylus tip geometries are available on request.

Technical Data

MFW standard set
consisting of:

Order No. 6111404

- | | |
|--|--------------------------|
| 1 Probe head | Order No. 6851801 |
| with inductive probe, measuring range $\pm 250 \mu\text{m}$ (± 0.01 in), tracing force approx. 0.7 mN, stylus tip geometry in accordance with DIN ISO, ASME, linearity deviation $\leq 1\%$ | |
| 2 Probe arm protection with skid | Order No. 6851802 |
| skid radius 25 mm (0.98 in), for skidded measurements | |
| 3 Probe arm protection without skid | Order No. 6851803 |
| 4 Probe arm | Order No. 6851804 |
| for bores with diameters of 4.5 mm (0.18 in) and over, stylus tip geometry in accordance with DIN ISO | |
| 5 Probe arm | Order No. 6851805 |
| for sunken surfaces, recesses or grooves, crank 10 mm (0.4 in) long, diameter 1 mm (0.04 in), stylus tip geometry in accordance with DIN ISO | |
| 6 Probe arm | Order No. 6851806 |
| with double probe arm length, measuring range extended to $\pm 500 \mu\text{m}$ (± 0.02 in); other data as for probe arm 4. | |

See page 25 for other probe arms.

MFW 250 Surface Probe

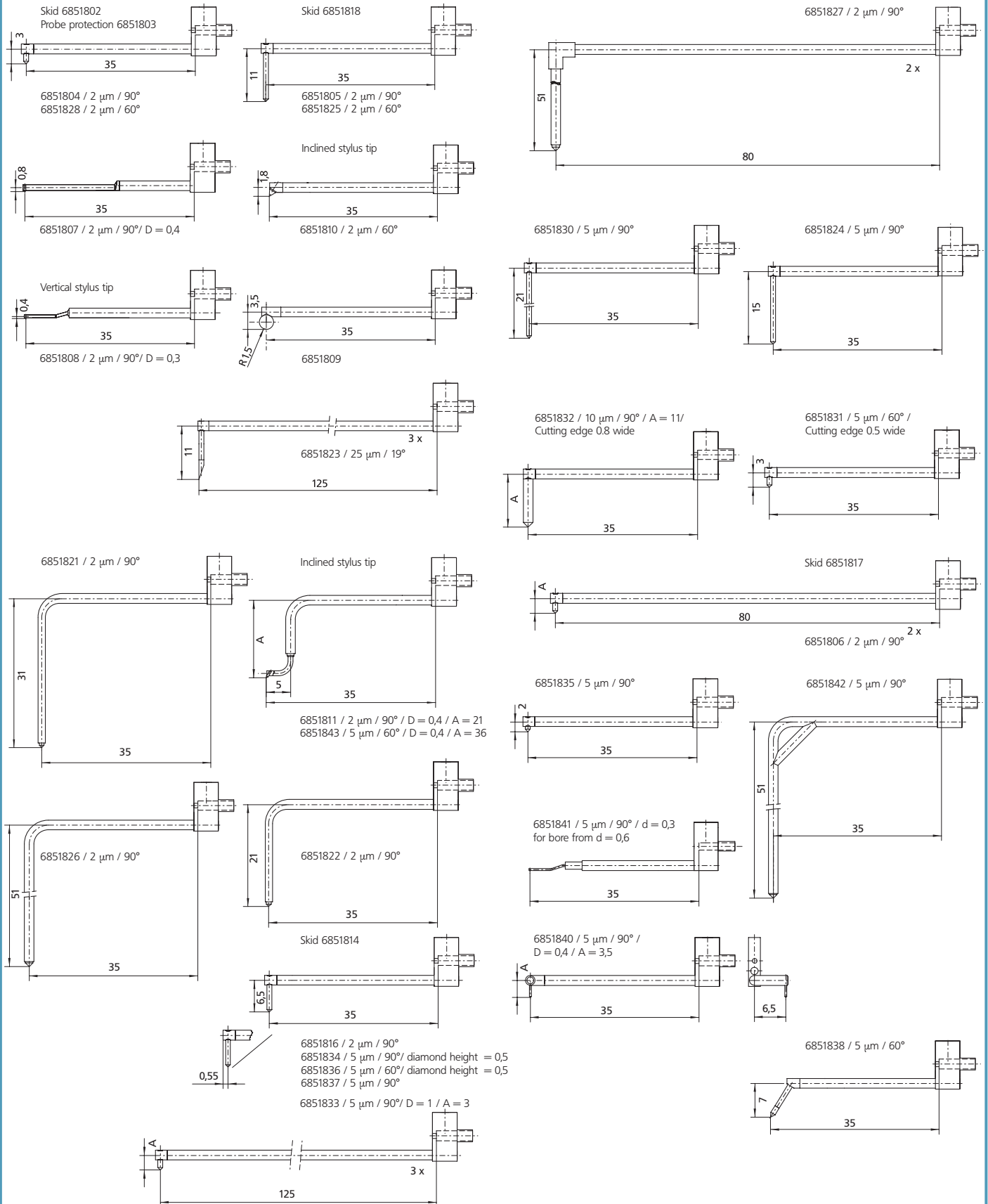

Surface Probes



MFW 1250

Order No. 6111405

A probe with a longer measuring stroke is required for special measurement tasks. The **MFW 1250** is the successor to the well-established **FRW 750** and is ideal for these requirements. The probe can be used with the **PGK 120** or **GD 120 CNC** drive unit. The **MFW 1250 set** comprises:

- **MFW 1250 probe head**
Order No. 6851701
measuring force of 2 mN to 6 mN
- **Probe arm** Order No. 6851704
for bores > 6 mm (0.24 in)
stylus tip radius 5 μm (200 μin)
- **Probe arm protection**
Order No. 6851703



RHTR 2-50; 2 μm (80 μin), 90° Order No. 6110460

Probe for roughness measurement on curved surfaces such as convex surfaces and grooves.
One spherical skid, skid radius in traversing direction 0.3 mm (0.0118 in), contact point 1 mm (0.039 in) next to stylus tip, tracing force approx. 0.7 mN, stylus tip geometry in accordance with DIN ISO.



RHTF

Probes for roughness measurement on tooth flanks

RHTF 0.5-50 probe
Order No. 6110665
(measurements possible from module 0.5)

RHTF-50 probe
Order No. 6110663
(measurements possible from module 2)

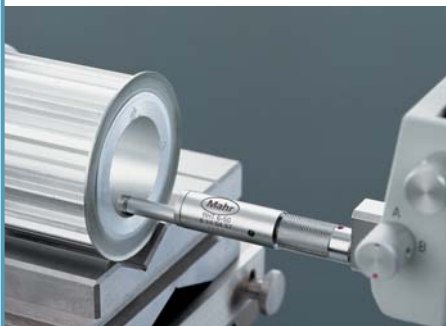

RHT 3, 6

Probes for roughness measurement in bores and on flat workpieces. Required workpiece length:
Traversing length + 0.9 mm (0.035 in).
One spherical skid, skid radius in traversing direction 25 mm (0.98 in), contact point 0.9 mm (0.035 in) in front of stylus tip. Tracing force approx. 0.7 mN. Stylus tip geometry in accordance with DIN ISO.

RHT 3-50, 5 μm (200 μin), 90°
Order No. 6110455

RHT 6-50, 2 μm (80 μin), 90°
Order No. 6110457

RHT 6-250, 2 μm (80 μin), 90°
Order No. 6110458



RTR-50 Order No. 6110337

Probe for roughness measurement on spheres and cylinders with diameters of 5 mm (0.197 in) and over in the circumferential direction.
Front skid, spherical, R = 3.2 mm (0.126 in)
Rear skid, cylindrical, R = 3.5 mm (0.138 in) in traversing direction, adjustable skid distance.



RT-250 SEP; 5 μm (200 μin), 90° Order No. 6110350

Probe for roughness measurement on flat surfaces and on cylindrical surfaces in the longitudinal direction. Required workpiece length:
Traversing length + 15 mm (0.59 in).
Can be used for bores with diameters of 12 mm (0.472 in) and over. The RT dual-skid probe is described in European standard EN 10049. This probe is particularly recommended for determining the roughness parameters of cold-rolled flat products (e.g. sheet metal). The probe automatically aligns itself with the surface thanks to its floating head.

Optical Probes

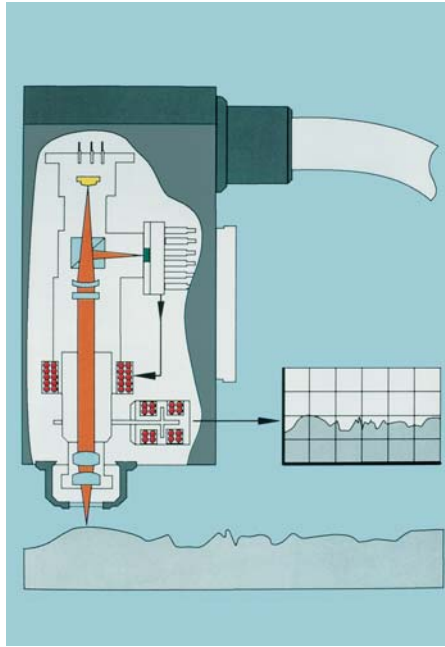

Focodyn and LS 1 / LS 10 probes

The **Focodyn**, **LS 1** and **LS 10** probes work according to the principle of dynamic focusing.

These optical probes are ideal for non-contact measurement of the surface of flat or curved workpieces made from sensitive materials (e.g. liquid or soft surfaces, paint, paper).

Measuring principle

The **LS 1** and **LS 10** probes work according to the principle of dynamic focusing. The infrared light from a laser diode is collected to form a parallel bundle of rays and brought to the lens.

The lens concentrates the beam so that it forms a measuring dot (focus) with a diameter of approx. 2 μm (80 μin) on the workpiece surface, 1 mm (0.04 in) (LS 1) or 10 mm (0.4 in) (LS 10) below the outlet aperture.

The light reflected by the surface is collected by the lens and directed to a focus detector. This detector converts the optical signal into an electrical one that incorporates the distance between the lens and the workpiece surface. A linear motor moves the lens so that the laser beam is always focused exactly on the surface.

As with mechanical probes, an inductive path measuring system converts the lens position into an electrical signal which is then processed by the evaluation instrument.

Technical Data

Optical probes	Focodyn	LS 1	LS 10
Measuring range	$\pm 25 \mu\text{m}$, $\pm 250 \mu\text{m}$ (± 0.001 in, ± 0.01 in)	$\pm 25 \mu\text{m}$, $\pm 250 \mu\text{m}$ (± 0.001 in, ± 0.01 in)	$\pm 25 \mu\text{m}$, $\pm 250 \mu\text{m}$ (± 0.001 in, ± 0.01 in)
Measuring distance	0.9 mm (0.0354 in)	1.0 mm (0.0394 in)	10.0 mm (0.394 in)
Measuring dot diameter	Approx. 2 μm (80 μin)	Approx. 2 μm (80 μin)	Approx. 2 μm (80 μin)
Laser light wavelength	780 nm (31 μin)	780 nm (31 μin)	780 nm (31 μin)
Dimensions (L x W x H)	160 mm x 12 mm x 38.5 mm (6.30 in x 0.47 in x 1.52 in)	43.5 mm x 27 mm x 80 mm (1.71 in x 1.06 in x 3.15 in)	43.5 mm x 27 mm x 137 mm (1.71 in x 1.06 in x 5.39 in)
Weight	Approx. 1.8 kg (3.97 lbs)	Approx. 130 g (0.29 lbs)	Approx. 130 g (0.29 lbs)
Order No.	6112015	6112007	6112008

Measuring Stands



ST-D measuring stand

The mount allows the drive unit to be inclined by $\pm 15^\circ$.

- **Vertical adjustment:** 0 mm to 300 mm (0 in to 11.81 in)
- **Triangular base**
- **Dimensions (L x W x H):** 175 mm x 190 mm x 385 mm (6.89 in x 7.48 in x 15.16 in)
- **Weight:** approx. 3 kg (6.61 lbs)

Order No. 6710803

Accessories:

- **GD 25 mount** on ST-D/F/G
Order No. 6851325
- **PZK mount** on ST-D/F/G
Order No. 6851328

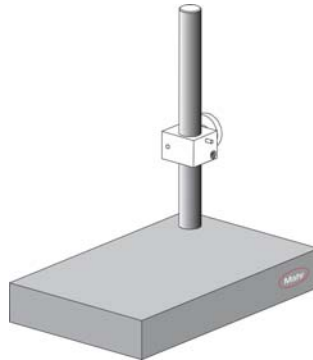

ST-F measuring stand

Granite base plate with no T-groove. The mount allows the drive unit to be inclined by $\pm 15^\circ$.

- **Vertical adjustment:** 0 mm to 300 mm (0 in to 11.81 in)
- **Table surface:** 400 mm x 250 mm (15.75 in x 9.84 in)
- **Material:** granite
- **Dimensions (L x W x H):** 400 mm x 250 mm x 422 mm (15.75 in x 9.84 in x 16.61 in)
- **Weight:** approx. 24 kg (52.91 lbs)

Order No. 6710806

Accessories:

- **GD 25 mount** on ST-D/F/G
Order No. 6851325
- **PZK mount** on ST-D/F/G
Order No. 6851328

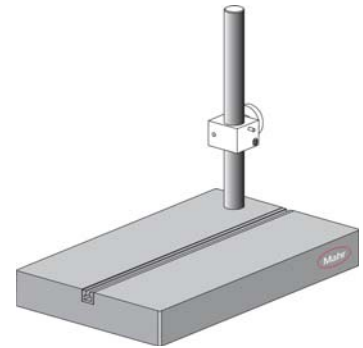

ST-G measuring stand

Granite base plate with a 10 mm (0.4 in) T-groove for fixing workpiece mounts. Vertical adjustment by means of a hand-wheel for easy and precise setting to the relevant measuring height. The mount allows the drive unit to be inclined by $\pm 15^\circ$.

- **Vertical adjustment:** 0 mm to 300 mm (0 in to 11.81 in)
- **on mount for PFM with handwheel**
- **Dimensions (L x W x H):** 500 mm x 300 mm x 415 mm (19.69 in x 11.81 in x 16.34 in)
- **Weight:** approx. 35 kg (77.16 lbs)

Order No. 6710807

Accessories:

- **GD 25 mount** on ST-D/F/G
Order No. 6851325
- **PZK mount** on ST-D/F/G
Order No. 6851328



ST 500/750/750 CNC measuring stands

The new MarSurf ST 500, ST 750 and ST 750 CNC measuring stands provide everything you need for a perfect surface measuring station. Decades of surface metrology experience have gone into this new design together with core expertise relating to vibration, smooth running and accommodation of environmental influences, thereby providing perfect conditions for a high-quality surface measuring station for roughness and contour measurements.

- Straightforward attachment of accessories with set of 10 mm (0.4 in) clamping slots
- Straightforward installation. Quick-action clamping device thanks to eccentric clamp
- 60 mm (2.36 in) adjustment in Y-direction

Optional:

- A centralized air supply allows controlled filling and refilling of the damping elements.

Measuring stand combinations

ST 500 complete **Order No. 6710250**
including granite plate
500 mm (19.69 in) travel
Plate size in mm: 700 x 550 x 90
in inches: (27.56 x 21.65 x 3.54)

ST 500 column **Order No. 6851350**

ST 750 complete **Order No. 6710251**
including granite plate
750 mm (29.53 in) travel
Plate size in mm: 700 x 550 x 90
in inches: (27.56 x 21.65 x 3.54)

ST 750 column **Order No. 6851351**

Granite plate **Order No. 6710580**
Plate size in mm: 1000 x 550 x 90
in inches: (39.37 x 21.65 x 3.54)

Measuring Stand Accessories

Mounts for ST 500 Measuring Stand

- LD 120 Order No. 6851360
- PGK 120 / GD 120 CNC Order No. 6851361
- PCV 200 Order No. 6851362
- Standard mount
GD 25 (PGK 20) Order No. 6851363
- Tube mount
GD 25 (PGK 20) Order No. 6851364
- Combi-mount
GD 25 / PCV 200 Order No. 6851369

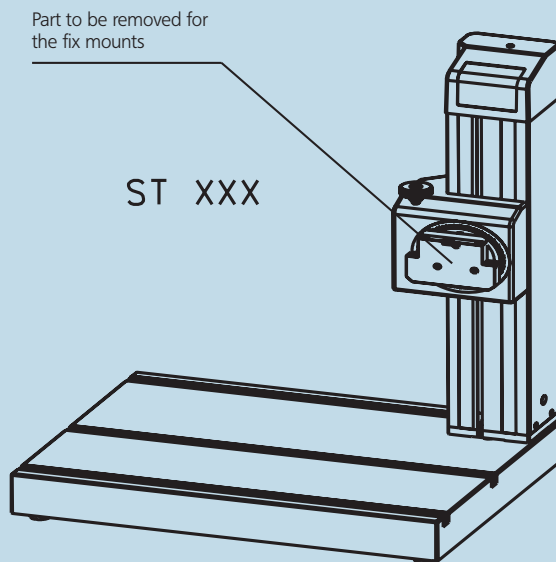

Fix mount for:

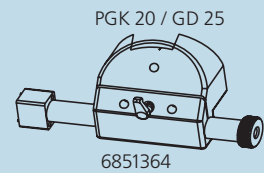

Changeable mounts for:

PGK 120 / GD 120 CNC

PCV 200 / CD 120

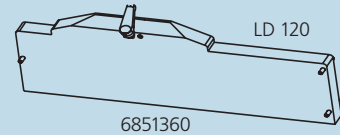
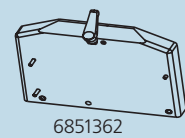
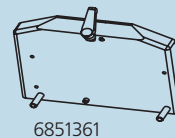

PGK 20 / GD 25

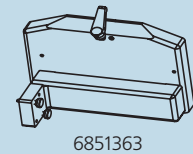

Combined mount for:

PGK 20 or GD 25
with PCV 200

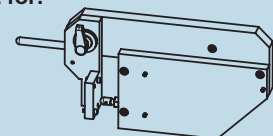

MarSurf. Damping Set (not illustrated)

Damping set for workpieces of 0 kg to 100 kg (0 lbs to 220.46 lbs)

MarSurf damping set 1 consists of:

- 4 pneumatic-spring elements
- Supply line kit
- Air pump (with pressure gage)

Load capacity: 20 kg to 60 kg x 4 units = 80 kg to 240 kg

Weight of granite plate + column: 80 kg + 50 kg = 130 kg

Max. permissible workpiece weight: Approx. 100 kg (220.46 lbs)

Order No. 6851368

Manual Control Panels

MCP 23

with emergency stop function and release button

Order No. 7035195

MCP 21

with LCD display and joystick

Order No. 7039135



Accessories



PP V-block unit Order No. 6710401

with four different V-blocks to mount rotary parts with test diameters of 1 mm to 160 mm (0.039 in to 6.30 in).
 Dimensions: 80 mm x 100 mm x 40 mm (3.15 in x 3.93 in x 1.58 in)
 Weight: 1.5 kg (3.31 lbs)
 Including tension springs to clamp light-weight workpieces in the V-block



PPS parallel vise Order No. 6710604

for clamping workpieces.

- Jaw width: 70 mm (2.76 in)
- Jaw height: 25 mm (0.98 in)
- Span: 40 mm (1.58 in)
- Total height: 58 mm (2.28 in)
- Weight: 2 kg (4.41 lbs)



CT 120 XY table Order No. 6710529

for mounting and aligning workpieces.

Can be moved 15 mm (0.59 in) in each of two coordinates.

Table surface: 120 mm x 120 mm (4.72 in x 4.71 in), with two quick-release jaws



Small parallel vises

Parallel vise for clamping small workpieces

Span: 32 mm (1.26 in)
 Dimensions (L x W x H):
 Approx. 130 mm x 32 mm x 40 mm (5.12 in x 1.26 in x 1.57 in)

- **Parallel vise**
Order No. 6710631
- **Articulated parallel vise**
Order No. 6710632
- **Parallel vise with base bracket can be swiveled axially by ± 45°**
Order No. 6710633



PKS ball vise Order No. 6710610

This item is based on the above PPS parallel vise.
 The ball-and-socket joint can be swiveled precisely in any required direction and rotated about 360°.

Total height: 150 mm (5.91 in)

Weight: 3.5 kg (7.72 lbs)



CT 200 XY table Order No. 6710530

Comes with versatile clamping options, three clamping slots (6 mm / 0.236 in), four M5 threaded bores and two quick-release jaws.

Clamping area 200 mm x 200 mm (7.87 in x 7.87 in) (option of extending to 400 mm x 400 mm (15.75 in x 15.75 in) with an adapter plate).

XY adjustment by 25 mm (0.98 in) each using micrometer screws.

C-axis can be adjusted by ± 2.5° for high-precision alignment of parts

Accessories



PURV 3-100 rotation device Order No. 6730702

for measurements on internal and external surfaces of axis-symmetrical parts. Work-piece diameters of 1 mm to 100 mm (0.0394 in to 3.94 in). Circumferential speed can be set to 0.5 mm/s or 0.1 mm/s (0.02 in/s or 0.004 in/s). With angle-restricting limit switches for segment measurements. Weight 5.5 kg (12.13 lbs)

Rim chuck, dia. 70 mm (2.76 in)
Order No. 6710614
Weight: 2 kg (4.41 lbs)

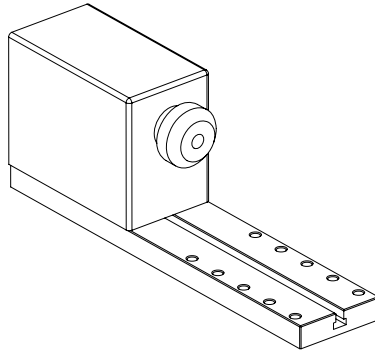

PLP table top for CT 200 Order No. 6710555

to accommodate rotation device or accessories.

Dimensions (L x W x H):
450 mm x 89 mm x 25 mm
(1.772 in x 3.50 in x 0.98 in)

With 6 mm (0.236 in) T-groove and T-groove nuts.



Equipment table Order No. 6830139

Dimensions (L x W x H):
1710 mm x 870 mm x 750 mm
(67.32 in x 34.25 in x 29.53 in).
Max. load capacity: 250 kg (551.16 lbs)
with continuous plate, PC base unit on the left and drawer unit on the right.



PGN 3 geometric standard Order No. 6820601

Surface standard with sinusoidal groove profile. Profile depth approx. 3 μm (120 μin), Ra value approx. 1 μm (40 μin). Groove spacing approx. 0.12 mm (0.0047 in). For dynamic monitoring of the roughness measuring station.

Mahr calibration certificate for PGN 3
Order No. 9027715
DKD calibration certificate for PGN 3
Order No. 6980102
PGN 1 geometric standard
Order No. 6820602
PGN 10 geometric standard
Order No. 6820605



PEN 10-1 setting standard Order No. 6820101

Depth setting standard for static calibration of all skidless probes and single/dual-skidless probes. Measuring groove depth approx. 10 μm (394 μin), diameter 44 mm (1.73 in).

Mahr calibration certificate for PEN 10-1
Order No. 9027782
DKD calibration certificate for PEN 10-1
Order No. 6980001



PRN 10 roughness standard Order No. 6820420

Including Mahr calibration certificate. Surface standard with turned profile, chrome-plated, profile depth approx. 10 μm (394 μin), for monitoring the roughness measuring station.

WWW.MAHR.COM

|
- 0 +

Mahr

E X A C T L Y

Mahr GmbH Göttingen

P.O. Box 1853, 37008 Göttingen, Germany
Carl-Mahr-Straße 1, 37073 Göttingen
Phone +49-551-7073-0, Fax +49-551-71021, eMail: info@mahr.de
www.mahr.com

© by Mahr GmbH, Göttingen
We reserve the right to modify our products, particularly with a view to
technical improvement and further development. All illustrations and
numbers etc. are therefore subject to change.